

EB120.0600

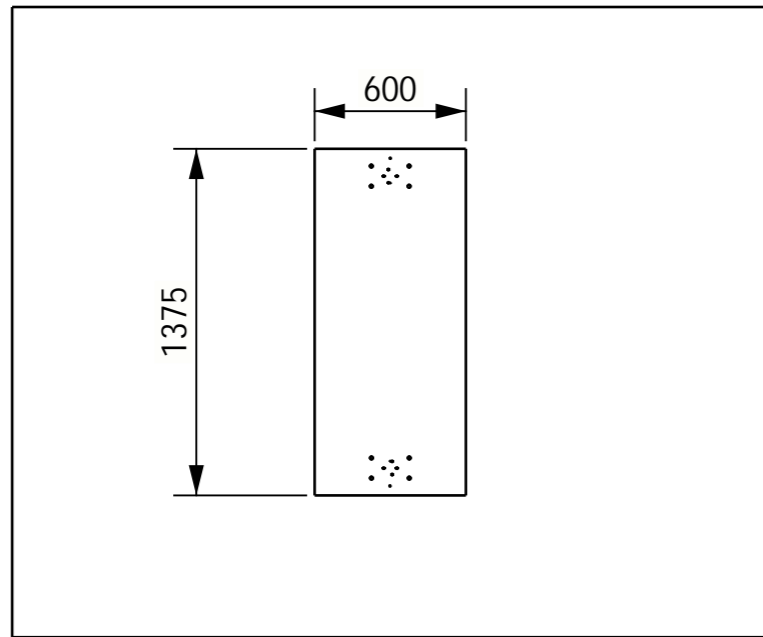

EB120.1200

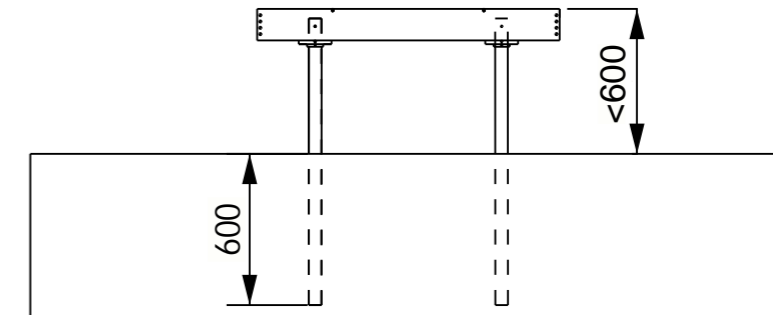
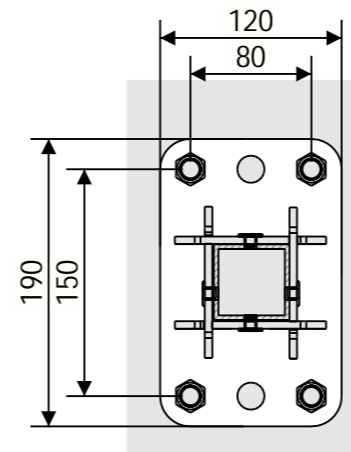
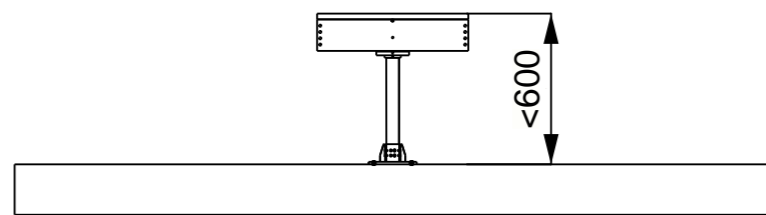
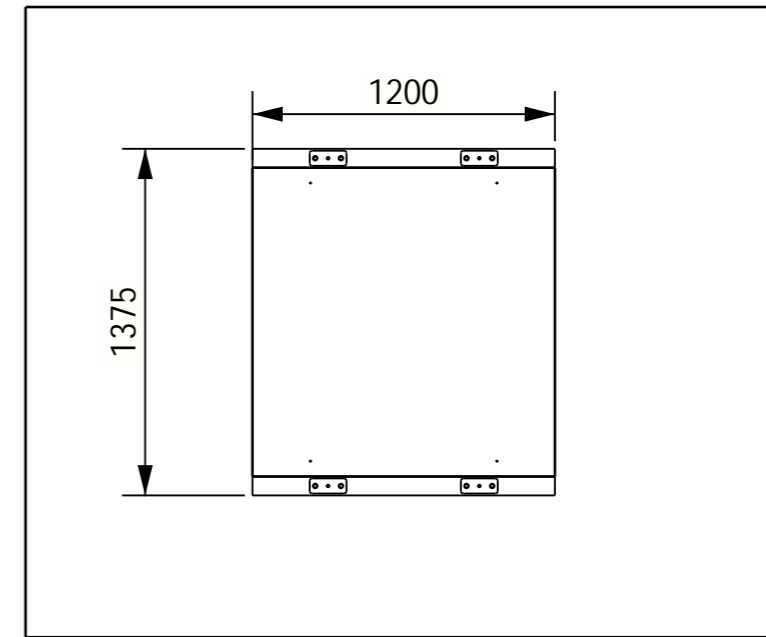

BASEPLATE

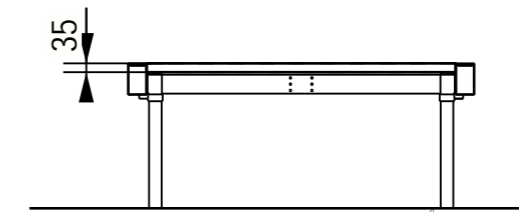
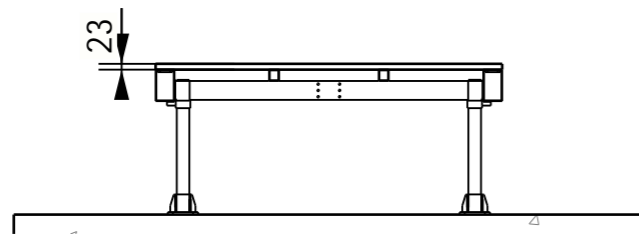

NO.	REVISION	DRAWN	DATE	 100 HENDERSON RD (Head Office) ROWVILLE VIC 3178 T\ 1800 663 339 E\ sales@moddex.com.au	SCALE	1:30	A3	CUSTOMER NAME:	JOB NO.			
					DI DRAWN	KLB	24/01/24	MODDEX				
					INS & PD DRAWN			PROJECT NAME:				
					INS & PD CHECKED			EZIBILT DRAWINGS	60***			
0	DRAWINGS CREATED	KLB	24/01/24		DESIGN COORDINATOR				ISSUE	A	B	C

EB120W.1800

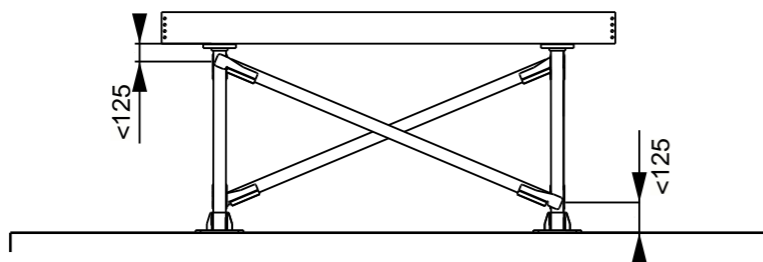
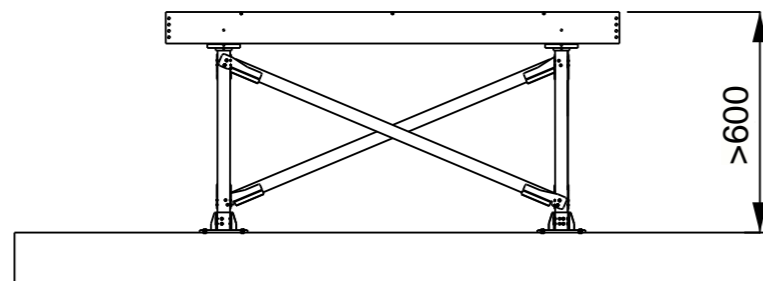
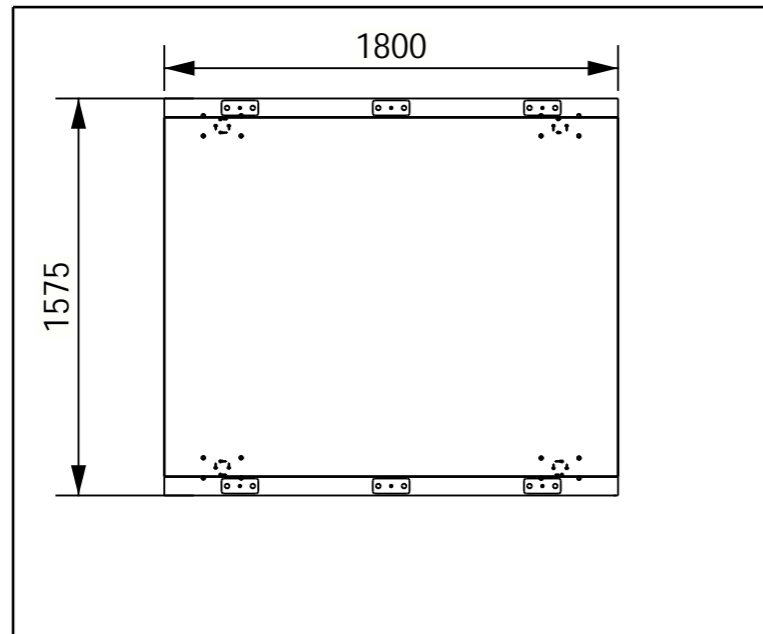

EB120W.2400

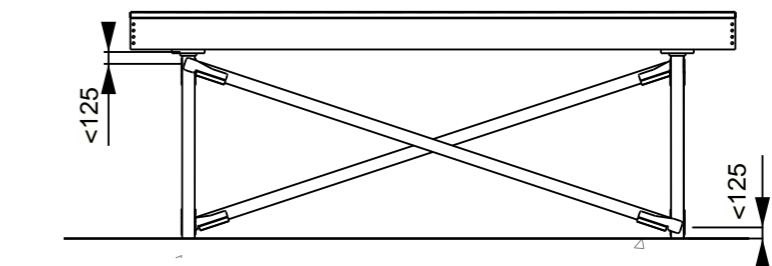
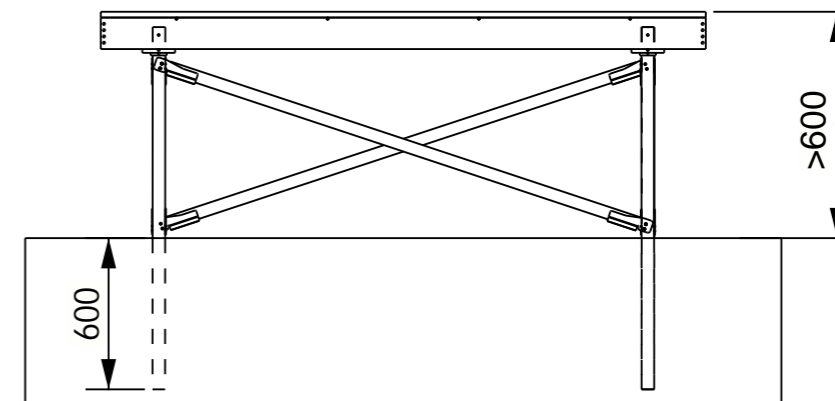
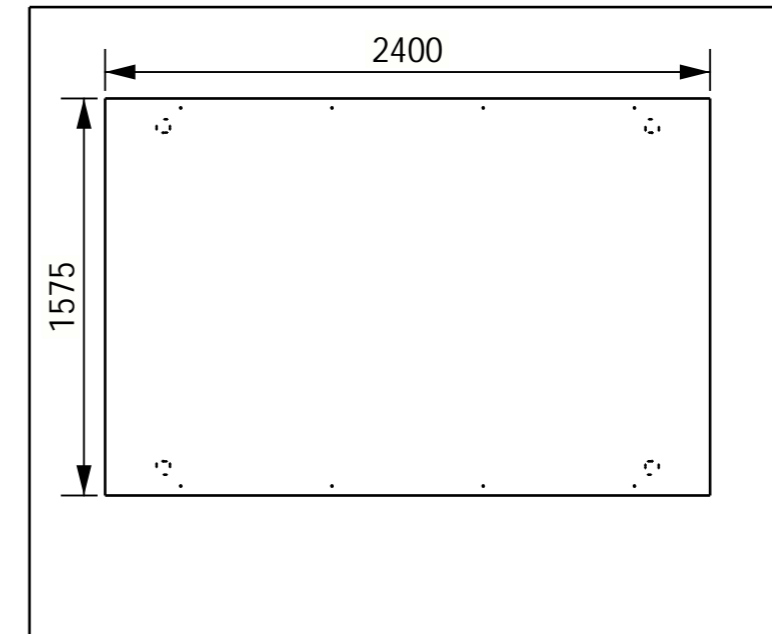

NO.	REVISION	DRAWN	DATE
0	DRAWINGS CREATED	KLB	24/01/24

moddex

100 HENDERSON RD (Head Office)
 ROWVILLE VIC 3178
 T\ 1800 663 339
 E\ sales@moddex.com.au

SCALE	1:30	A3
DI DRAWN	KLB	24/01/24
INS & PD DRAWN		
INS & PD CHECKED		
DESIGN COORDINATOR		

CUSTOMER NAME:	MODDEX
PROJECT NAME:	EZIBILT DRAWINGS

JOB NO.	18***
ISSUE	A B C D

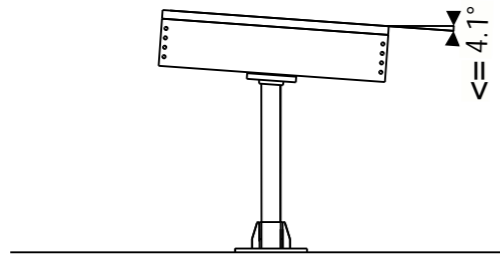

EB120.0600

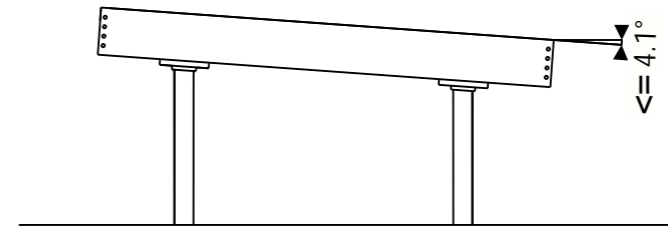

EB120.1200

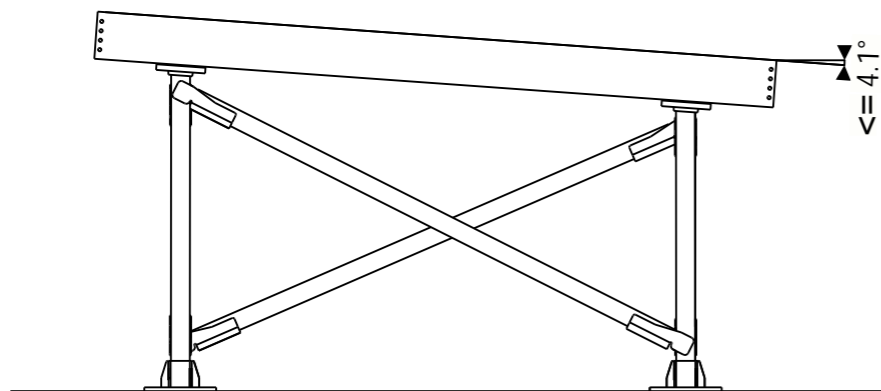

EB120W.1800

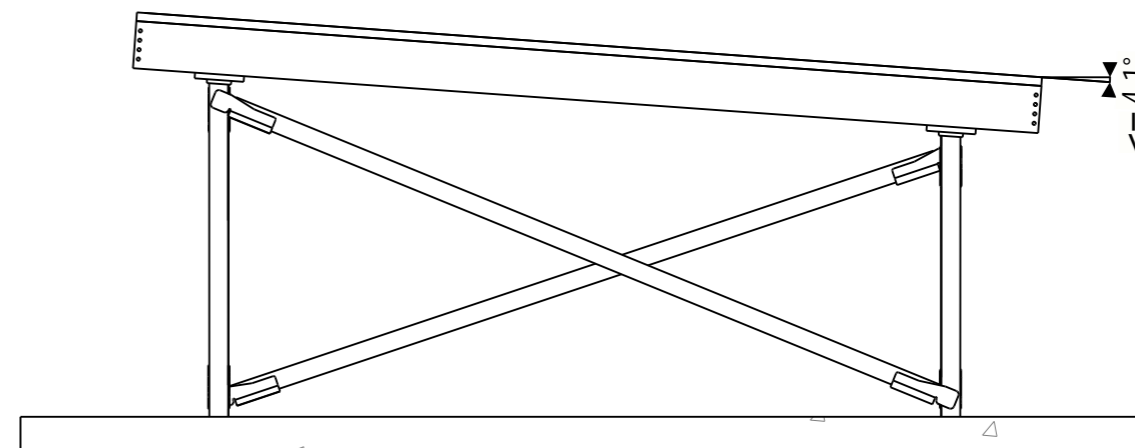

EB120W.2400

NO.	REVISION	DRAWN	DATE	 100 HENDERSON RD (Head Office) ROWVILLE VIC 3178 T\ 1800 663 339 E\ sales@moddex.com.au	SCALE	1:30	A3	CUSTOMER NAME:	JOB NO.			
					DI DRAWN	KLB	24/01/24	MODDEX				
					INS & PD DRAWN			PROJECT NAME:				
0	DRAWINGS CREATED	KLB	24/01/24		INS & PD CHECKED			EZIBILT DRAWINGS	AN***			
				DESIGN COORDINATOR				ISSUE	A	B	C	D